

**BIXOLON®**

**User's Manual**

**SRP-B300**

---

**THERMAL RECEIPT PRINTER**

**Ver. 1.00**

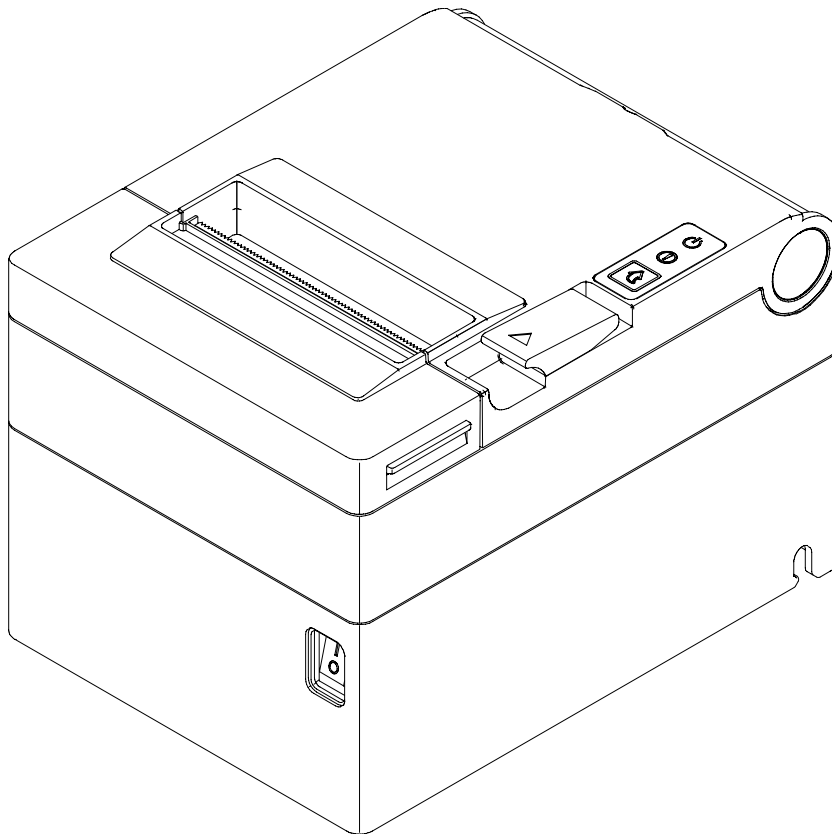

<http://www.bixolon.com>

## Introduction

SRP-B300 series printers have been designed to be connected to various types of electronic devices such as POS (Point Of Sales), and computer peripheral devices.

**※ The main features of the printer are as follows**

1. THERMAL RECEIPT PRINTER
2. Low-noise thermal transfer method printing
3. Maximum 200mm/s printing speed
4. 132 x 178.4 x 124.7 (W X D X H)
5. On Board USB/Ethernet/Serial
6. Equipped with data buffer (receives print data even while printing)
7. Can print a range of barcodes
8. Range of printing density selectable  
(controlled with virtual memory switch management)

It is advisable to read the contents of this manual carefully before using the printer for the first time.

**※ Use only authorized supplies that can be trusted!**







- We are not responsible for quality and service for damage caused by the use of unauthorized products (or recycled ones).

## Safety Information

 **Warning:** Warnings must be heeded carefully in order to prevent serious physical harm.

 **Caution:** Cautions must be heeded in order to prevent minor injuries, equipment damage, or data loss.

## Symbol Information

	DC (Direct current)
	Error, Warning
	Paper Feeding
	Stand-By
	USB
	Ethernet

# **Table of Contents**

<b>1. Installing Printer and Getting Started</b> .....	<b>5</b>
1-1 Unpacking .....	5
1-2 Interface .....	6
1-2-1 USB Interface.....	6
1-2-2 Ethernet Interface.....	7
1-2-3 Serial Interface .....	8
1-3 Drawer Port .....	9
1-4 Connecting Power Supply .....	10
1-5 Reconfiguration of Printer.....	12
1-6 Installing & Replacing Paper .....	13
1-7 Recommended Papers .....	16
1-8 Removing Paper Jam.....	16
1-9 Using Printer Functions.....	17
<b>2. Self-Test</b> .....	<b>18</b>
<b>3. Hexadecimal Dumping</b> .....	<b>20</b>
<b>4. Specifications</b> .....	<b>21</b>
<b>5. Appendix</b> .....	<b>22</b>
5-1 Cleaning Printer .....	22

# 1. Installing Printer and Getting Started

## 1-1 Unpacking

- Check the following contents list, and contact your dealer for assistance if any item is missing or incorrect.

### - Product

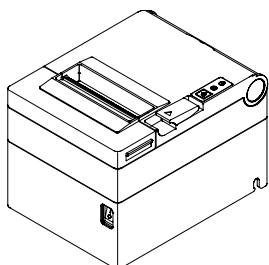

SRP-B300

### - Standard Components

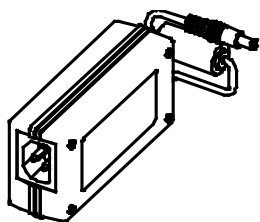

AC/DC Adaptor

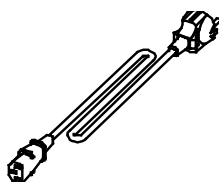

Power Cord

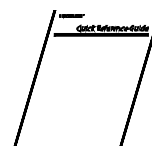

Installation Guide

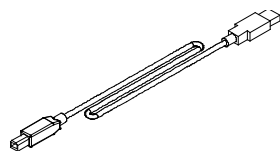

USB A-B Cable

### - Optional Components

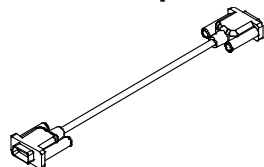

Serial Cable (9pin - 9pin)

**1-2 Interface**

- Connect the printer to the host computer using the right interface cable that complies with the specifications of the interface

**1-2-1 USB Interface**

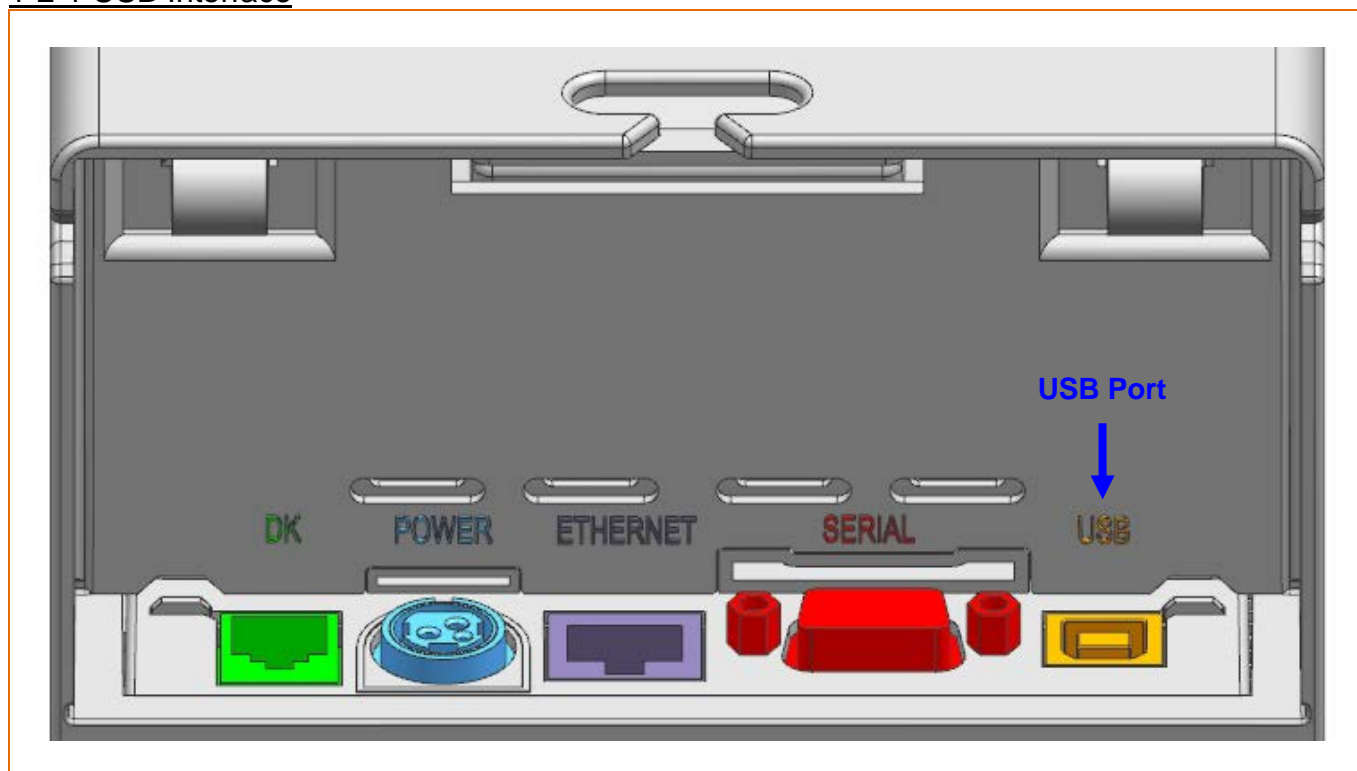

Pin No.	Signal Name	Designation (Color)	Function
Shell	Shield	Drain Cable	Frame Ground
1	VBUS	RED	Host Power
2	D-	WHITE	Data Line (D-)
3	D+	GREEN	Data Line (D+)
4	GND	BLACK	Signal Ground

**⚠ Caution** All cables must be connected while the product is turned off.

**1-2-2 Ethernet Interface**

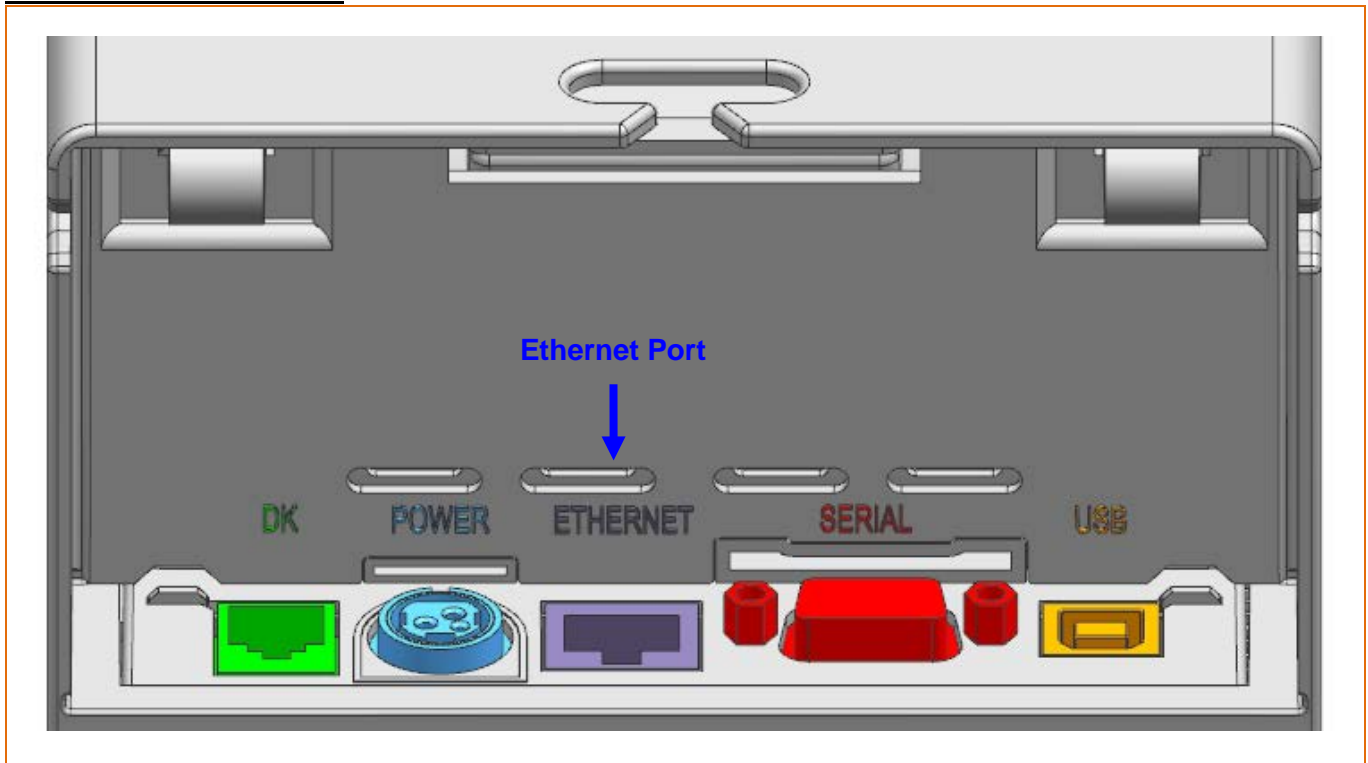

Pin No.	Signal Name	Designation (Color)	Function
1	TD+	WHITE ORANGE	Transmit +
2	TD-	ORANGE	Transmit -
3	TCT	WHITE GREEN	-
4	NC	BLUE	-
5	NC	WHITE BLUE	-
6	RCT	GREEN	-
7	RD+	WHITE BROWN	Receive +
8	RD-	BROWN	Receive -

\* Refer to the Ethernet User's Manual that is available from the BIXOLON website for more detailed information.

 <b>Caution</b>	All cables must be connected while the product is turned off.
--	---

1-2-3 Serial Interface

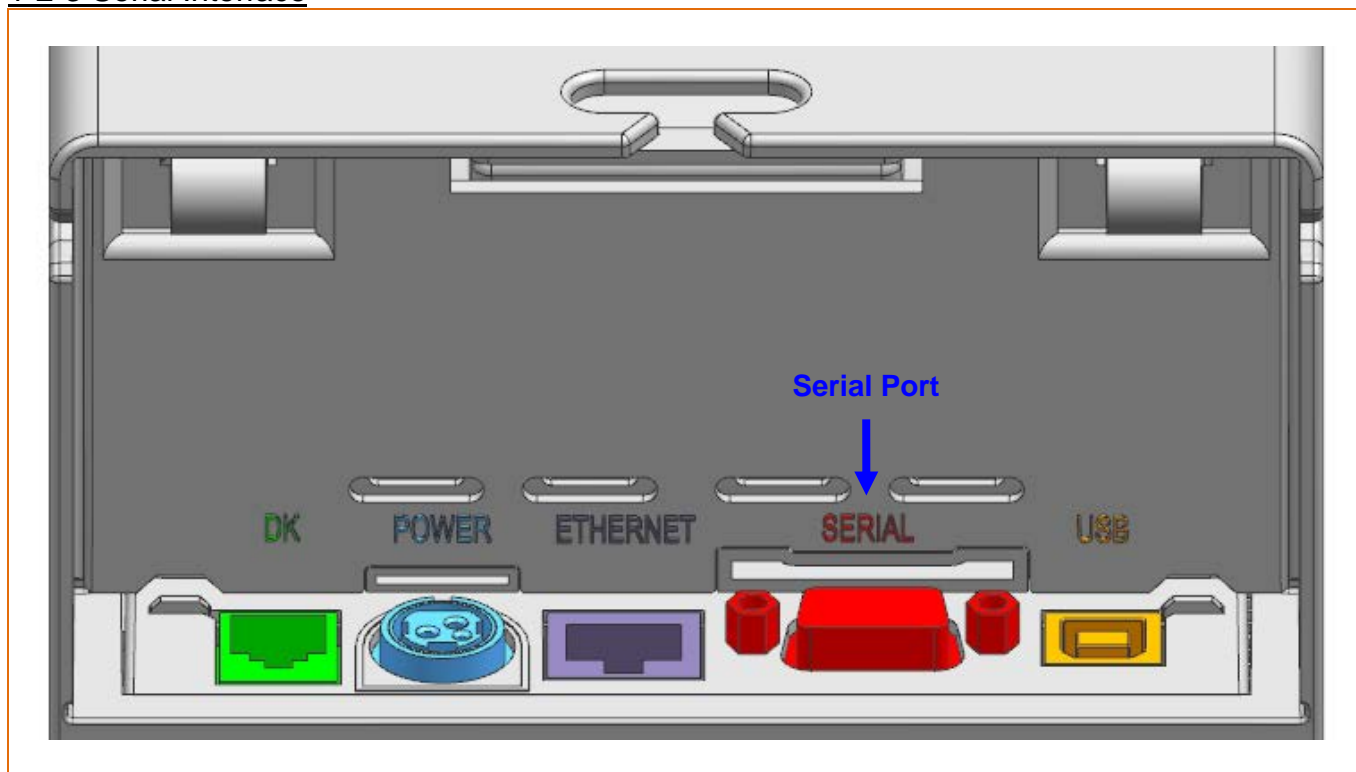

Pin No.	Signal Name	Direction	Function
1	NC	-	-
2	TxD	OUTPUT	Transmit Data
3	RxD	INPUT	Receive Data
4	DSR	INPUT	Data Set Ready
5	GND	-	-
6	DTR	OUTPUT	Data Terminal Ready
7	CTS	INPUT	Clear To Send
8	RTS	OUTPUT	Ready To Send
9	NC	-	-



All cables must be connected while the product is turned off.



**1-3 Drawer Port**

- Connect the cash drawer connection cable to the drawer kick-out connector on the rear side of the printer.

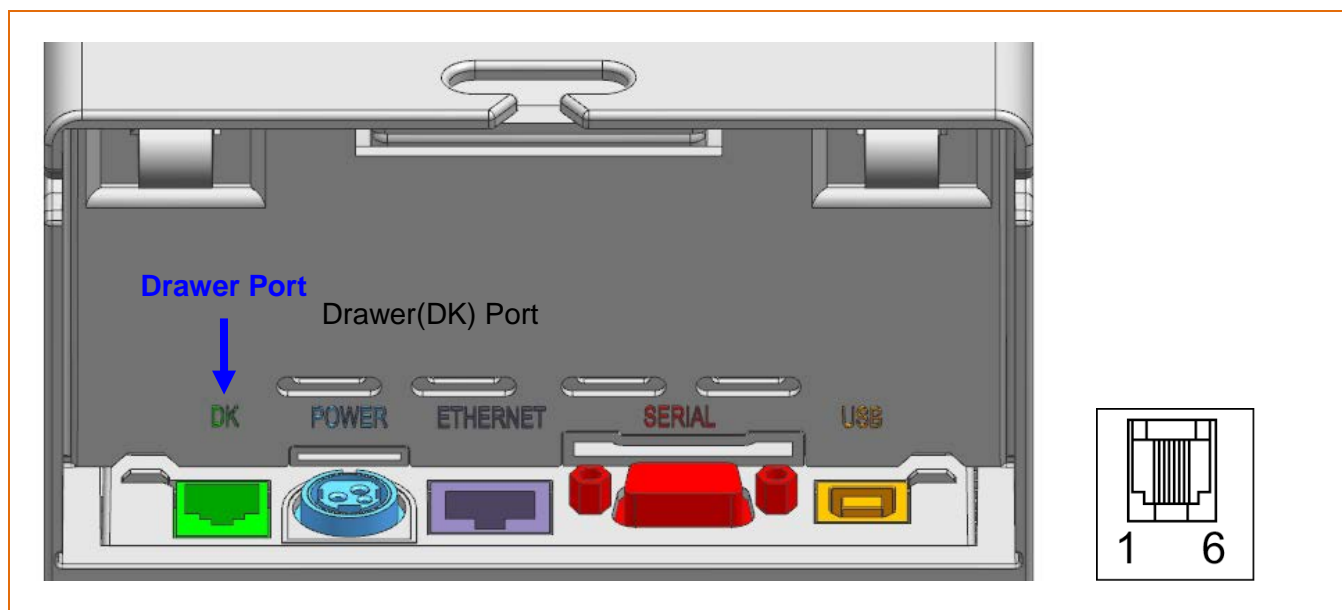

Pin No.	Signal Name	Direction
1	Frame Ground	-
2	Drawer Kick-out Drive Signal 1	Output
3	Drawer Open/Close Signal	Input
4	+24V	-
5	Drawer Kick-out Drive Signal 2	Output
6	Signal Ground	-

**⚠ Caution**

- Use a cash drawer that meets the printer specifications. Using a cash drawer that is inappropriate to the specs or using it as a power supply for a separate device may result in damage to the product
- Do not connect a telephone line to the drawer kick-out connector. Otherwise, the telephone line and the computer may be damaged.
- Do not allow a foreign object such as a conductor to touch the cash drawer port. This may result in damage to the product
- Make sure to use a cash drawer with an internal coil resistance of 24 Ω or higher. (The maximum current is 1A.)
- The open signal time for the cash drawer should not exceed 0.8 seconds. After opening the cash drawer, make sure to idle for at least 3.2 seconds (at least 4 times that of the open signal time) before operating it.

**1-4 Connecting Power Supply**

- 1) Make sure the product is turned off before connecting the power supply.
- 2) Connect the power cable with the flat side pointing to the outside of the printer, as shown in the diagram below.

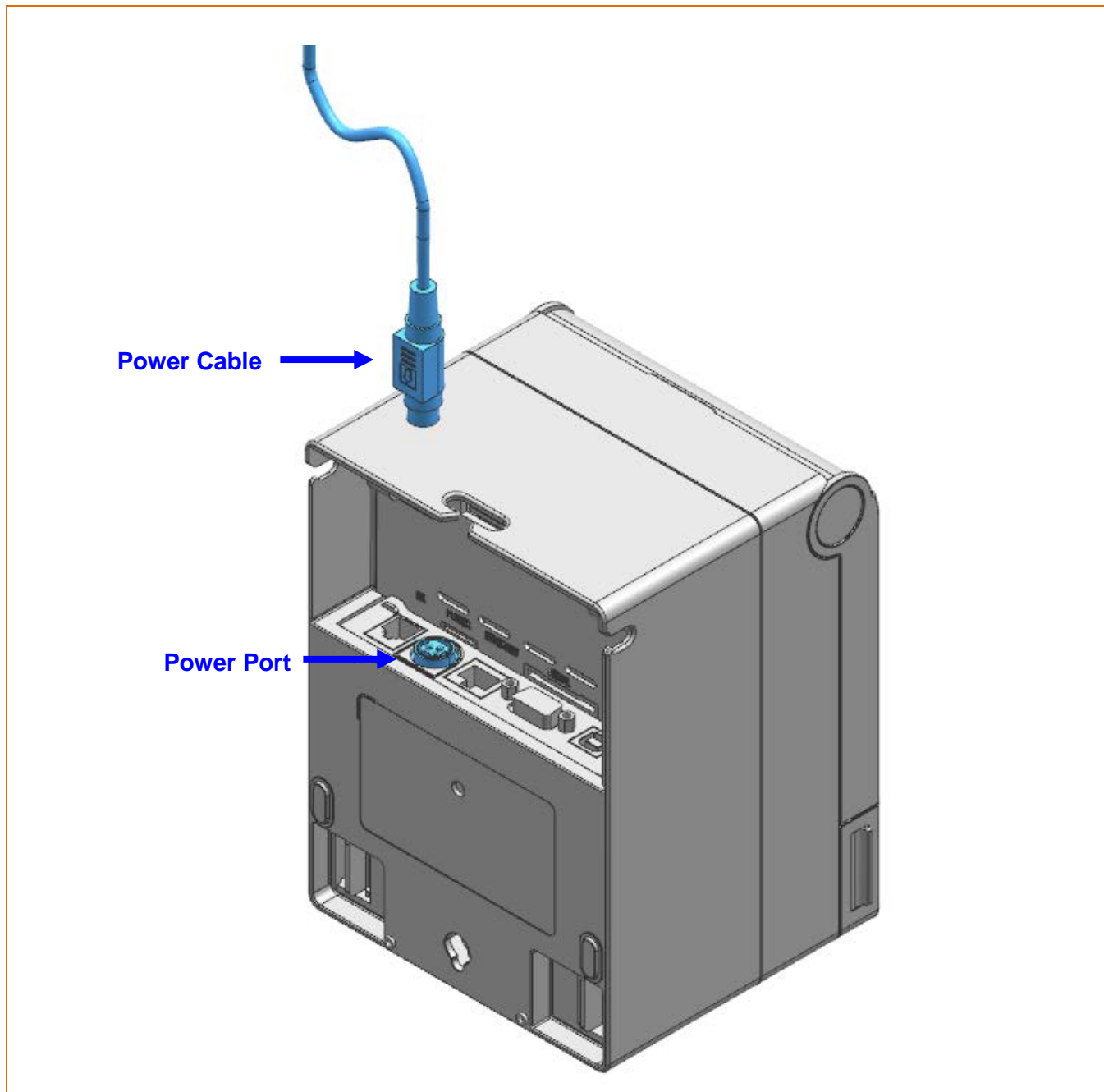

- Only use a power supply provided by Bixelon. Bixelon shall bear noresponsibility for damage caused by using a third-party power supply.
- Check the power supply's label to check its electronic specs.
- When removing the power supply, make sure you have a firm grasp of the plug terminal of the power cable and the printer and pull horizontally.
- When connecting or disconnecting power, make sure to remove the power supply from the power outlet before removing.
- Pay attention to the direction in which you insert the power cable.

 **Caution**

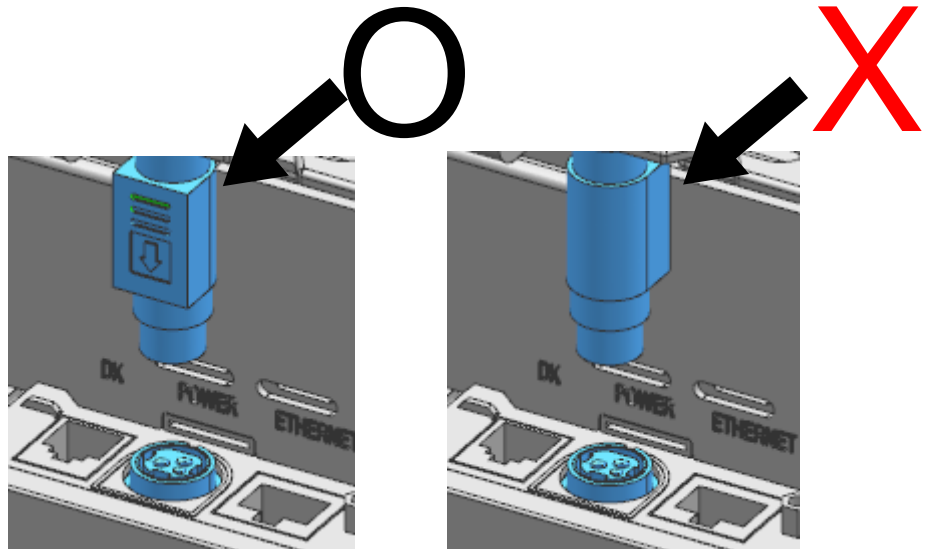

 **Warning**

**Do not connect a voltage out of the specifications of the power supply. It can cause damage to the product or a fire.**

**1-5 Reconfiguration of Printer**

- This product does not support Dip Switch. In order to change the product's configuration, use either the virtual memory switch utility or the virtual memory switch management function when performing a self-diagnosis.
- Please refer to the Utility and Service Manual for more information.



**Caution**

Make sure to turn the printer off and on again after using the virtual memory switch utility to adjust the settings of the product.

**1-6 Installing & Replacing Paper**

1) Open the paper roll cover by raise the cover-open lever.

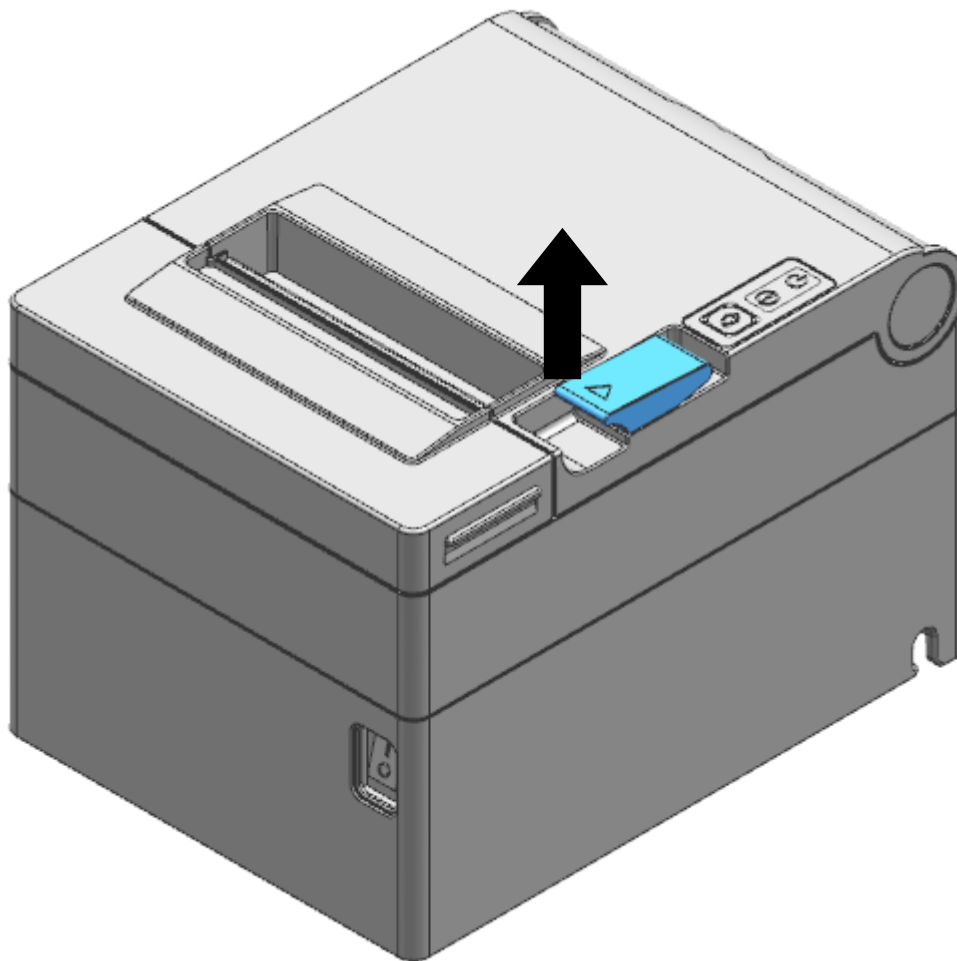

Do not open the print cover while the printer is operating, otherwise the printer may be damaged.

2) Remove the empty paper roll and replace with a new one as shown in the image.

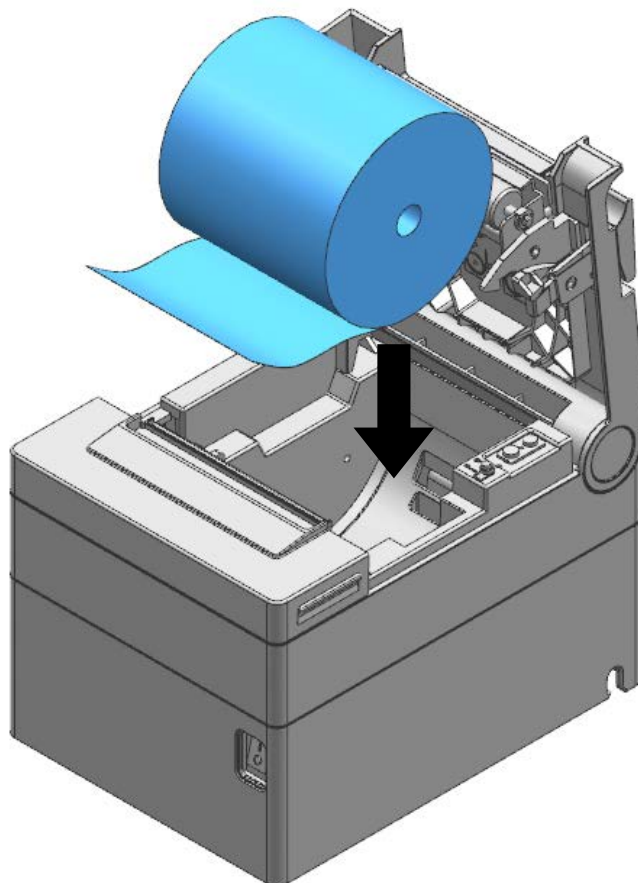

Check the orientation of the roll paper when inserting it into the printer.

 **Caution**

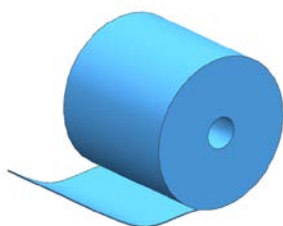

**O**

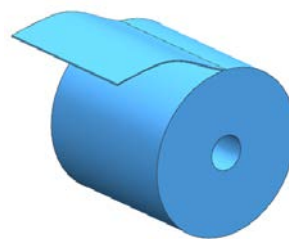

**X**

3) Pull out a small amount of paper as shown in the picture, and close the cover.

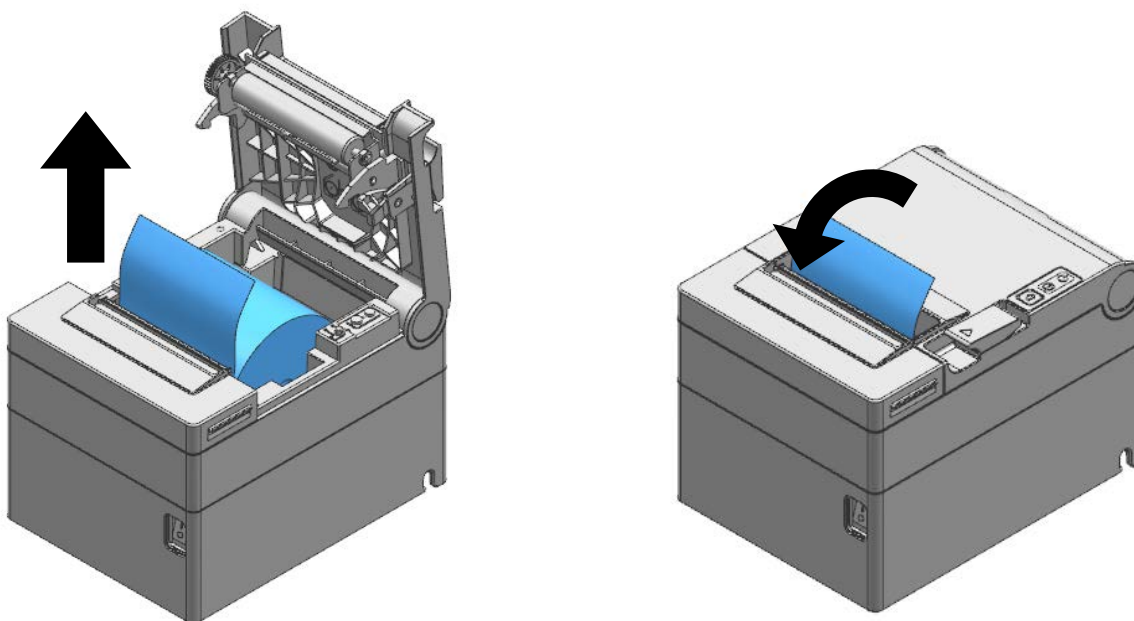
**Caution**

When closing the cover, hold down the center of printer cover firmly so that paper roll is loaded correctly.

4) Cut the paper as shown in the following picture.

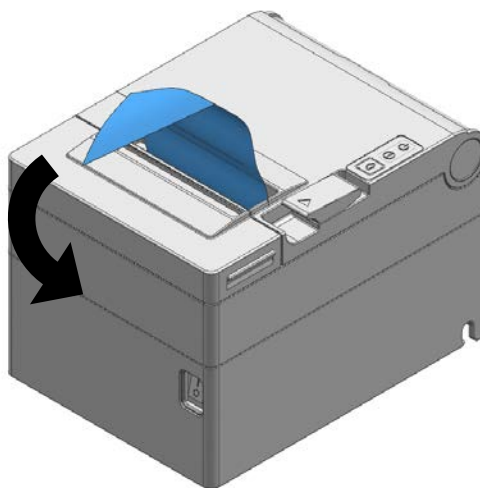
**Caution**

- Make sure to use the specified paper only.
- To prevent data loss, replace paper only when the printer is not receiving any data.



**1-7 Recommended Papers**

- TF50KS-E (Paper Thickness: 65µm): Nippon Paper Industries Co., Ltd.
- PD 150R (Paper Thickness: 75µm): New Oji Paper Mfg. Co., Ltd.
- PD 160R (Paper Thickness: 75µm): New Oji Paper Mfg. Co., Ltd.
- P350 (Paper Thickness: 62µm): Kansaki Specialty Paper, Inc. (USA)
- P220AG (Paper Thickness: 65µm): Mitsubishi Paper Mills Limited
- P220A (Paper Thickness: 65µm): Mitsubishi Paper Mills Limited
- F5041 (Paper Thickness: 65µm): Mitsubishi HitecPaper Flensburg GmbH
- P5047 (Paper Thickness: 60µm): Mitsubishi Paper Mills Limited

 <b>Caution</b>	<ul style="list-style-type: none"> <li>- Use of papers other than those recommended above may damage TPH or degrade the printing quality and our company is not responsible for the damage caused by non-recommended papers.</li> <li>- If you have to use other products, we recommend that you use papers with a similar level of quality to the recommended ones.</li> </ul>
--	---

**1-8 Removing Paper Jam**

- Open the cover and remove the jammed paper.

 <b>Caution</b>	<ul style="list-style-type: none"> <li>- Placing your hand above the printer outlet may cause a paper jam.</li> <li>- If the cover will not open due to a minor paper jam, turning the power OFF → ON will automatically return the blade to its original position.</li> </ul>
 <b>Warning</b>	<p><b>If the cover does not open, do not use tools such as screw drivers, and call the customer center. Forcing the cover open may result in faulty paper cutting or damage to the product.</b></p>



**1-9 Using Printer Functions**



• **Power (Button)**

- The POWER light is on whenever the printer is on.



• **Error (Indicator Lamp)**

- Red light will be on in various error conditions such as out of paper, cover open, etc.



• **Feed (Button)**

- Press this button to feed the paper out. Hold down this button to feed out the paper continuously.



**Caution**

If the printer does not power on, check that the adapter LED indicates "ON"

## 2. Self-Test

The self-test checks whether the printer has any problems. If the printer does not function properly, contact your dealer. The self-test procedure is as follows:

- 1) Make sure paper roll has been installed properly.
- 2) Turn on the power while holding down the FEED button and the self-test begins.
- 3) The self-test prints the current status of the printer including control ROM version.
- 4) After printing the current printer status, the printer wait for the next step after printing the following lines. (The paper signal light keeps blinking.)

### **SELF-TEST PRINTING.**

**Select a button to run the following.**

**Continue test printing : Press the button briefly**

**Memory switch configuration mode : Press and hold down button**

- 5) Press the Feed button to resume printing or hold down the button for at least one second to change the VMSM settings.

- If "Continuous SELF-TEST" is selected

- (1) Press the Feed button for less than one second to print the preset page.
- (2) The self test ends automatically as it prints the following line and cuts the paper

**\*\*\* COMPLETED \*\*\***

- (3) The printer goes into normal print mode upon completion of the self test.

- If “VMSM Selection” is selected

(1) The following lines will be printed when the VMSM opens.

**\*\* VMSM Selection \*\***  
**0 : Exit and reboot printer**  
**1 : Print current settings**  
**2 : Set Print Density**  
**3 : Set Cutting mode**  
**4 : Set External Buzzer after cutting**  
**5 or more : None**

(2) Press the Feed button to run the above function.

- Step 1(Select Options): press the button a number of times as shown by each menu.
- Step 2(Enter Options): hold down the button for at least one second to apply each item selected.



**Note**

If you select any items not listed above, the list of “VMSM Selection” will be printed again.  
Setting the mode will be canceled if no item is selected in Step 1.

(3) Hold down the Feed button for at least 1 second to save the changes.  
The following line will be printed before cutting the paper.

If “0: Exit and reboot printer” is not executed, the new settings will not be saved.

**\*\*\* COMPLETED \*\*\***

6) The new settings will be automatically applied when printer resets.



**Caution**

Contact the customer center if the setting changes are not saved.

### 3. Hexadecimal Dumping

This function allows experienced users to see exactly what data is coming to the printer. This can be useful in finding software problems. When you turn on the hexadecimal dump function, the printer prints all commands and data in hexadecimal format along with a guide section to help you find specific commands.

To use the hexadecimal dump function, follow these steps.

- 1) After making sure that the printer is off, open the cover.
- 2) Turn the printer on, while holding down the FEED button.
- 3) Close the cover, and then the printer enters the hexadecimal dump mode.
- 4) Select the hexadecimal printing function in the mode selection menu to move to the hexadecimal printing mode.
- 5) Run any software program that sends data to the printer.  
The printer will print all the codes it receives in a two-column format.  
The first column contains the hexadecimal codes and the second column gives the ASCII characters that correspond to the codes.

```

1B 21 00 1B 26 02 40 40 40 40    . ! . . & . @ @ @ @
02 0D 1B 44 0A 14 1E 28 28 28    . . . D . . . . ( ( (
00 01 0A 41 0D 42 0A 43 43 43    . . . A . B . C C C

```

- A period (.) is printed for each code that has no ASCII equivalent.
- During the hex dump, all commands are disabled.

- 6) When the printing finishes, turn off the printer.
- 7) Turn on the printer and then the hexadecimal mode is off.



**Caution**

Contact the customer center if the printer does not enter hexadecimal printing mode.

## 4. Specifications

Printing Method		Thermal printing
Dot Density		203 dpi (8dots/mm)
Printing Width		3 inches                      72 mm
Roll Width		3 inches                      79.5±0.5 mm
No. of Characters per Line (Default Value)		48 (Font A) ,64 (Font B), 64 (Font C)
Printing Speed		Max. 200 mm/sec
Receiving Buffer Size		4K bytes
Interface		USB, Ethernet, Serial
Cash Drawer		2ports with Y-type cable
Supply Voltage	SMPS Input Voltage	100~240 VAC
	Frequency	50/60 Hz
	SMPS Output Voltage	24 VDC
Environment Condition	Temperature	Operating: 0 ~ 40 °C Storage: -20 ~ 60 °C
	Humidity	Operating: 10 ~ 80 % RH Storage: 10 ~ 90 % RH Paper excluded
Life Span	Printer Head *)	100 Km
	Auto Cutter	1,000,000 cuts

\*) The specifications were determined based on operation at normal temperature using designated paper on default settings. They are subject to change depending on temperature or printing level.



### **Caution**

Printing speed may become slightly slower depending on the data transmission speed and the combination of commands.

## 5. Appendix

### 5-1 Cleaning Printer

- Paper dust inside the printer may lower the print quality.  
In this case clean the printer as follows:

- 1) Open the printer cover and remove the paper currently in use.
- 2) Residue or contamination of printer head should be wiped out by ethanol or IPA.

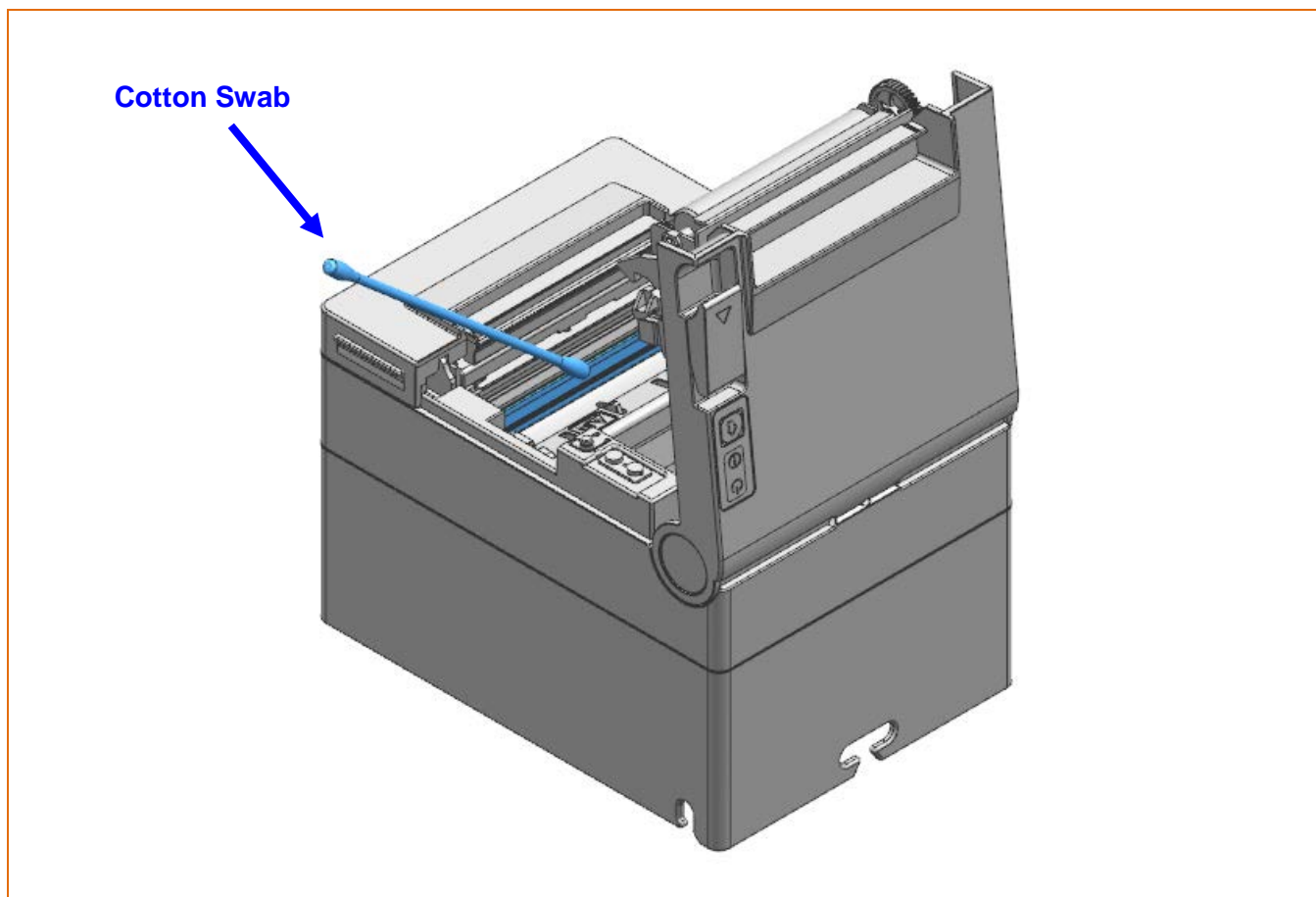

- 3) Clean the paper sensor and paper roller with a cotton swab or a dry cloth.
- 4) Insert a paper roll and close the printer cover.

**Caution**

When cleaning the printer head, make sure that cleaning solutions such as ethanol or IPA do not penetrate the printer.

**Warning**

**Do not touch the printer head immediately after printing, as it could burn the skin.**

## Copyright

© BIXOLON Co., Ltd. All rights reserved.

This user manual and all property of the product are protected under copyright law. It is strictly prohibited to copy, store, and transmit the whole or any part of the manual and any property of the product without the prior written approval of BIXOLON Co., Ltd. The information contained herein is designed only for use with this BIXOLON product. BIXOLON is not responsible for any direct or indirect damages, arising from or related to use of this information.

- The BIXOLON logo is the registered trademark of BIXOLON Co., Ltd.
- All other brand or product names are trademarks of their respective companies or organizations.

BIXOLON maintains ongoing efforts to enhance and upgrade the functions and quality of all our products.

In the following, product specifications and/or user manual content may be changed without prior notice.

## Warning - U.S.A

This equipment has been tested and found to comply with the limits for a Class A digital device pursuant to Part 15 of the FCC Rules. These limits are designed to provide reasonable protection against harmful interference when the equipment is operated in a commercial environment. This equipment generates uses, and can radiate radio frequency energy and, if not installed and used in accordance with the instruction manual, may cause harmful interference to radio communications. Operation of this equipment in a residential area is likely to cause harmful interference in which case the user will be required to correct the interference at his own expense.

ii) Changes or modifications not expressly approved by the manufacturer could void the user's authority to operate the equipment.

iii) Caution: Exposure to Radio Frequency Radiation.

To comply with FCC RF exposure compliance requirements, a separation distance of at least 20 cm must be maintained between the antenna of this device and all persons.

## Notice - Canada

i) Class A Digital Device : Wired Device

This Apparatus complies with class "A" limits for radio interference as specified in the Canadian department of communications radio interference regulations.

Get appareil est conforme aux normes class "A" d'interference radio tel que specifier par ministre canadien des communications dans les reglements d'interference radio.

## Caution

Some semiconductor devices are easily damaged by static electricity. You should turn the printer “OFF”, before you connect or remove the cables on the rear side, in order to guard the printer against the static electricity. If the printer is damaged by the static electricity, you should turn the printer “OFF”.

## Waste Electrical and Electric Equipment (WEEE)



This marking shown on the product or its literature, indicates that it should not be disposed with other household wastes at the end of its working life. To prevent possible harm to the environment or human health from uncontrolled waste disposal, please separate this from other types of wastes and recycle it responsibly to promote the sustainable reuse of material resources. Household users should contact either the retailer where they purchased this product, or their local government office, for details of where and how they can take this item for environmentally safe recycling. Business users should contact their supplier and check the terms and conditions of the purchase contract. This product should not be mixed with other commercial wastes for disposal.



