

USER MANUAL

BOX PC INEOS 800

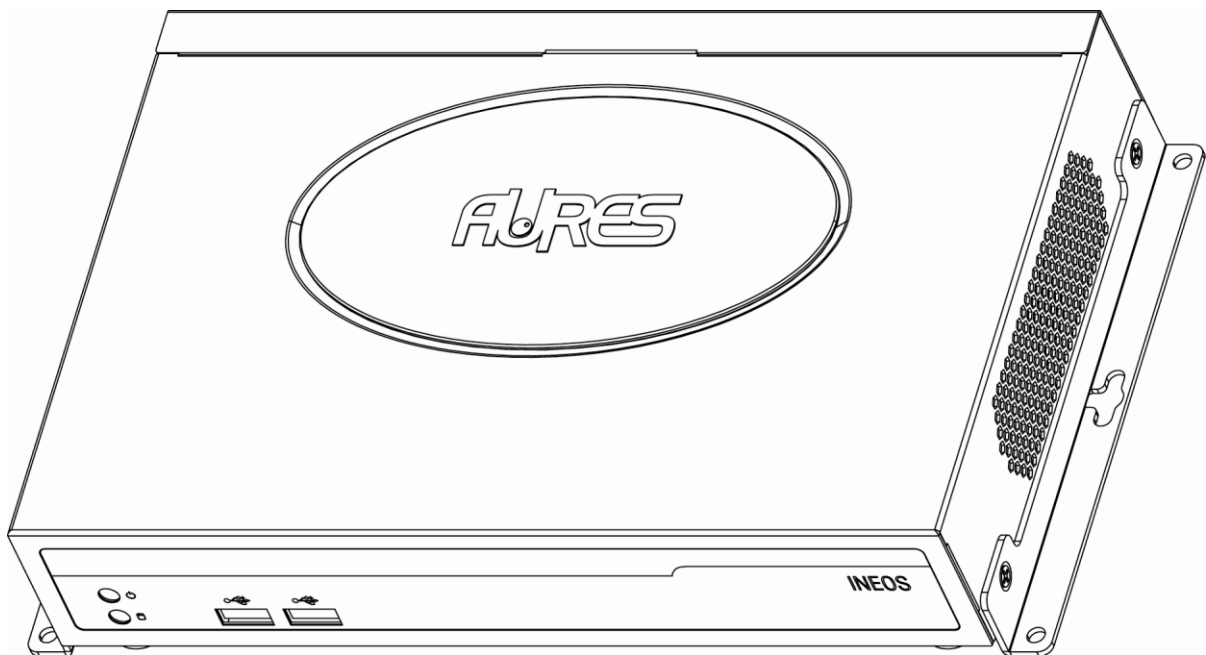

Copyright Notice

This document is copyrighted, 2012. All rights are reserved.

The information contained in this document is subject to change without notice in advance. We make no warranty of any kind with regard to this material, including, but not limited to, the implied warranties of merchantability and fitness for a particular purpose. We shall not be liable for errors contained herein or for incidental or consequential damages in connection with the furnishing, performance, or use of this material.

This document contains proprietary information that is protected by copyright. All rights are reserved. No part of this document may be photocopied, reproduced or translated to another language without the prior written consent of the manufacturer.

Trademark

Intel® and Pentium® are registered trademarks of Intel® Corporation. Microsoft® and Windows® are registered trademarks of Microsoft Corporation. Other trademarks mentioned herein are the property of their respective owners.

IMPORTANT SAFETY INSTRUCTIONS

Please read these safety instructions carefully and keep this User's Manual for later reference. Ensure to follow all warnings and instructions marked on the product. Never open the equipment. For safety reasons, the equipment should be opened only by qualified service personnel.

1. Disconnect this equipment from any AC outlet before cleaning. Use a damp cloth. Do not use liquid or spray detergents for cleaning.
2. For plug-in equipment, the power outlet socket must be located near the equipment and must be easily accessible.
3. Put this equipment on a reliable surface during installation. Dropping it or letting it fall may cause damage.
4. The openings on the enclosure are for air convection. Protect the equipment from overheating. **DO NOT COVER THE OPENINGS.**
5. Make sure the voltage of the power source is correct before connecting the equipment to the power outlet.
6. Position the power cord so that people cannot step on it. Do not place anything over the power cord.
7. If the equipment is not used for a long time, disconnect it from the power source to avoid damage by transient overvoltage.
8. Please carry the unit with both hands, handle with care.
9. Properly maintain and clean the surfaces, use only approved products or clean with a dry applicator.
10. If one of the following situations arises, get the equipment checked by service personnel:
 - a. The power cord or plug is damaged.
 - b. Liquid has penetrated into the equipment.
 - c. The equipment has been exposed to moisture.
 - d. The equipment does not work well, or you cannot get it to work according to the user's manual.
 - e. The equipment has been dropped and damaged.
 - f. The equipment has obvious signs of breakage.
11. All cautions and warnings on the equipment should be noted.

<p><i>Warning</i></p> 	<ul style="list-style-type: none">● <i>Keep this equipment away from humidity. Never pour any liquid into an opening. This may cause fire or electrical shock.</i>● <i>This equipment shall not be used for life support system.</i>
---	---

IMPORTANT SAFETY STATEMENT

This equipment has been tested and found to comply with the limits for a Class A digital device, pursuant to Part 15 of FCC Rules. These limits are designed to provide reasonable protection against harmful interference when the equipment is operated in a residential environment. This equipment generates uses and can radiate radio frequency energy. If not installed and used in accordance with this user's manual, it may cause harmful interference to radio communications.

Note that even when this equipment is installed and used in accordance with this user's manual, there is still no guarantee that interference will not occur. If this equipment is believed to be causing harmful interference to radio or television reception, this can be determined by turning the equipment on and off. If interference is occurring, the user is encouraged to try to correct the interference by one or more of the following measures:

<i>Warning</i> 	<i>Any changes or modifications made to the equipment which are not expressly approved by the relevant standards authority could void your authority to operate the equipment.</i>
---	--



This device complies with the requirements of the EEC directive 2004/108/EC with regard to “Electromagnetic compatibility” and 2006/95/EC “Low Voltage Directive”.



This device complies with part 15 of the FCC rules for a Class A digital device. Operation is subject to the following two conditions:

- (1) This device may not cause harmful interference.
- (2) This device must accept any interference received, including interference that may cause undesired operation.

CAUTION ON LITHIUM BATTERIES

If your computer is losing dramatic time or the BIOS configuration reset to default, the battery has no power. Do not replace battery yourself. Please contact a qualified technician or your retail. Contact your sales representative for technical support if you need additional assistance. This is because a danger of explosion will occur if the battery is replaced incorrectly.

<i>Warning</i> 	<ul style="list-style-type: none">● <i>Input voltage rated 24 VDC, 3.5 A maximum (DC Mode)</i>● <i>Use a 3 V @ 195mA lithium battery (Model No. CR2032)</i>
---	--

LEGISLATION AND WEEE SYMBOL

The box PC follows the national requirement to dispose unit. Business users should contact their supplier and check the terms and conditions of the purchase contract. This product should not be mixed with other commercial wastes for disposal.



Revision History

Changes to the original user manual are listed below:

Revision	Description	Date
1.0	Initial release	December 2012

Table of Contents

1. Packing List	1
1-1. Standard Accessories	1
2. System View	2
2-1. Front and Side View	2
2-2. I/O View	3
2.3. Dimensions.....	4
3. Components Replacing	5
3-1. HDD Replacing	5
3-2. Mounting Kit Disassembling	6
3-3. Memory Replacing	7
4. Specification	8
5. Jumper Setting	9
5-1. Motherboard Layout	9
5-2. Connectors & Functions	10
5-3. Jumper Setting	11
5-4. Pin Define.....	12,13,14
6. Driver Installation	15
6-1. Chipset Driver	15
6-2. Graphic Driver	16,17
6-3. Audio Driver	18
6-4. LAN Driver.....	19
Appendix: Driver Installation	20

1. PACKING LIST

1-1. Standard Accessories

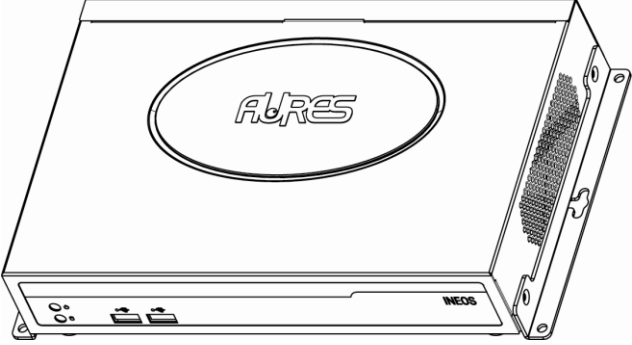
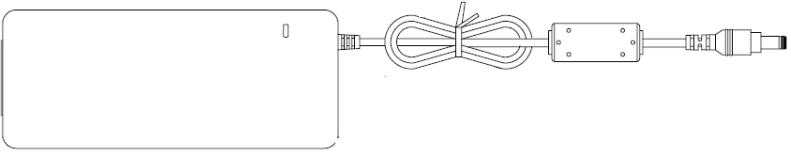
a. System box	
b. Power adapter	

2. System View

2-1. Front and Side View

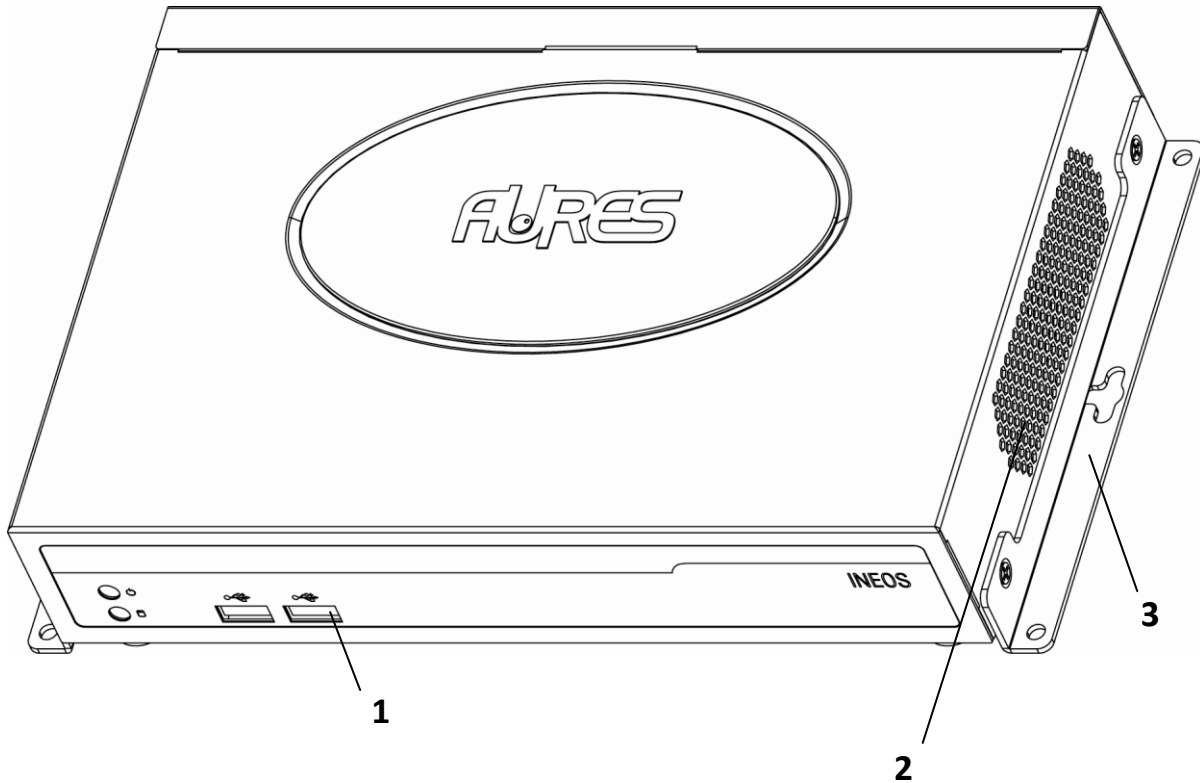

1. I/O placement
2. Ventilation holes
3. Mounting brackets

Warning



Do not leave this equipment in an uncontrolled environment where the storage temperatures is below 10 °C(-14°F) or above 50°C (122° F). This may damage the equipment.

2-2. I/O View

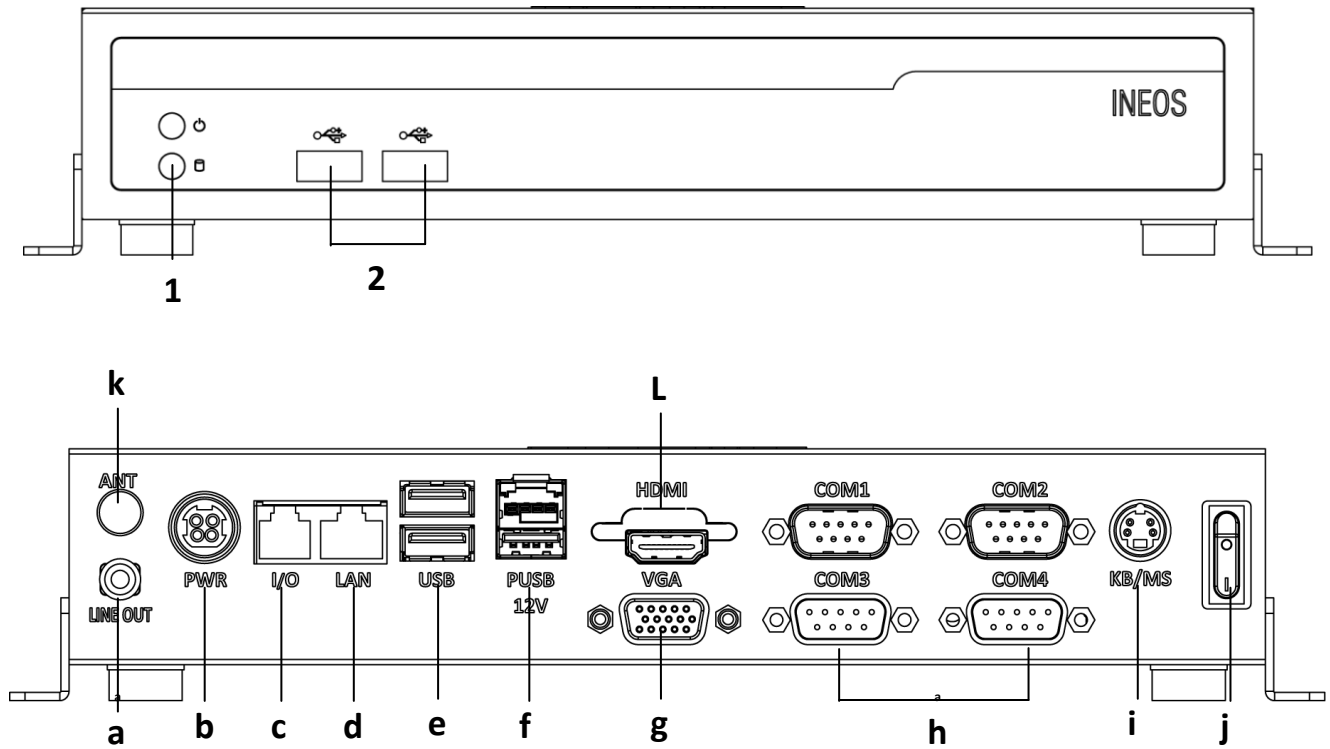

Item No.	Description
1	Power & HDD LED indicators
2	USB x 2
a	Line-Out
b	DC Jack
c	Cash Drawer Port
d	Lan port
e	USB x 2
f	12V powered USB x 1
g	VGA port
h	COM Port x 4 (COM1 & COM2: with RI/5V/12V)
i	Keyboard /Mouse port (P/S2 port)
j	Power button
k	Antenna hole
L	HDMI port

2-3. Dimensions (Unit: mm)

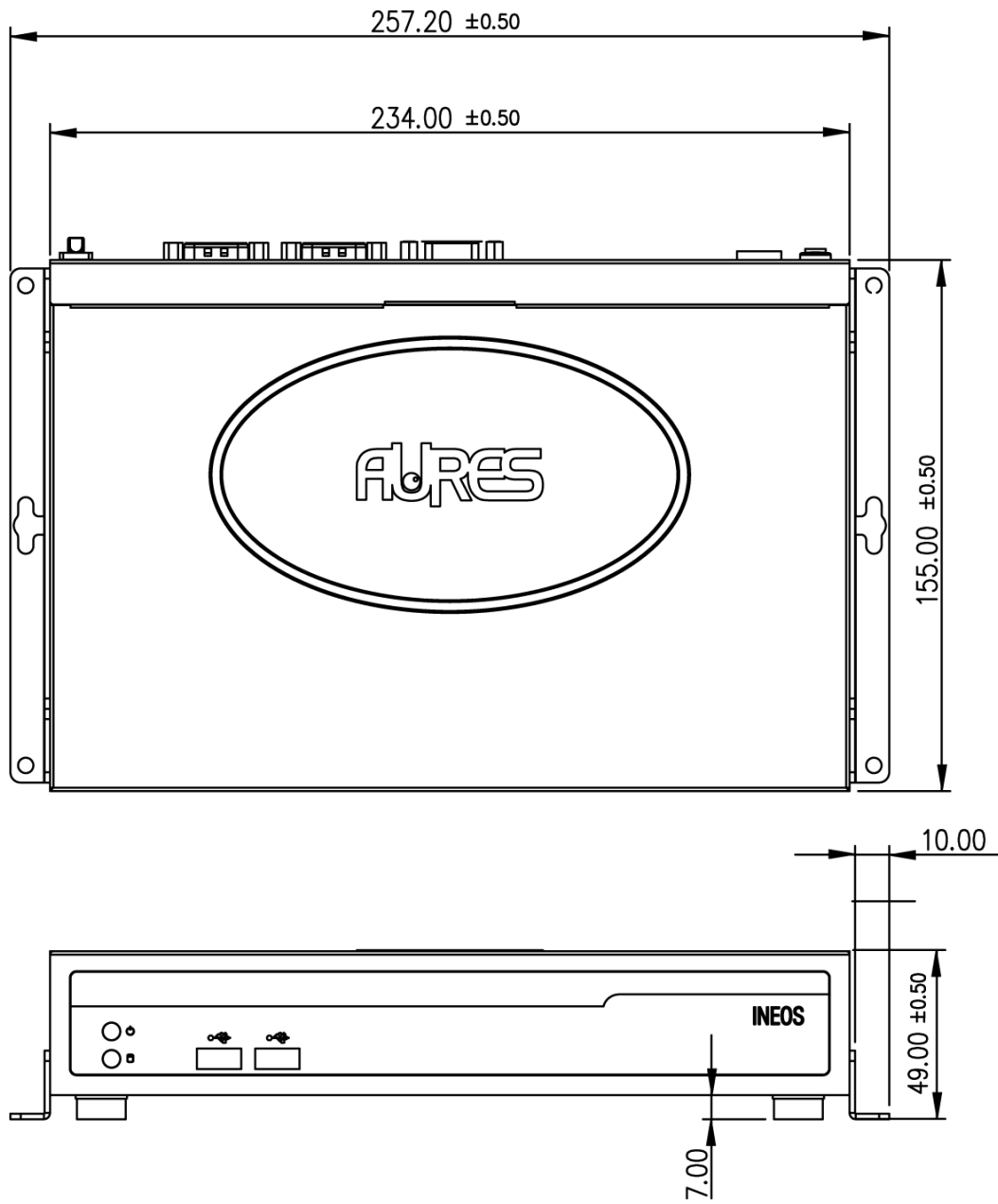

3. Components Replacing

3-1. HDD Replacing

1. Turn system unit upside down and HDD door is located in the bottom.
2. Open the HDD door by unfastening the screw (x2).
3. Disconnect the HDD connectors (x2) and replace the HDD.

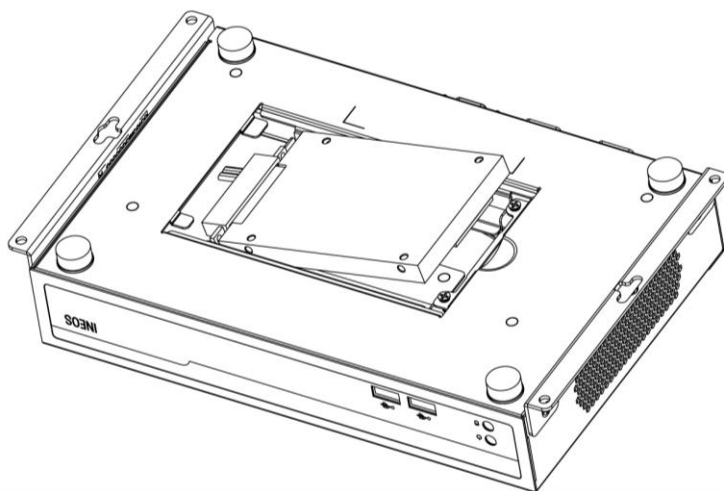
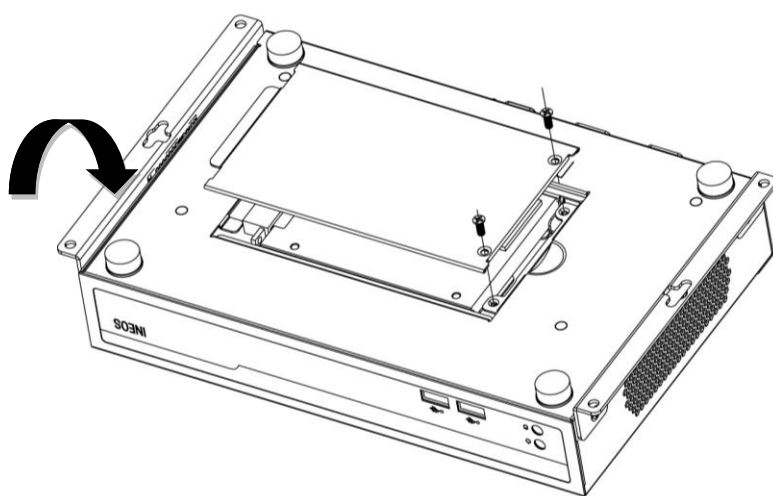

3-2. Mounting Kit Disassembling

The box PC comes with wall mount brackets and if you do not need it. You can unfasten the screws (x4) by the side of box PC.

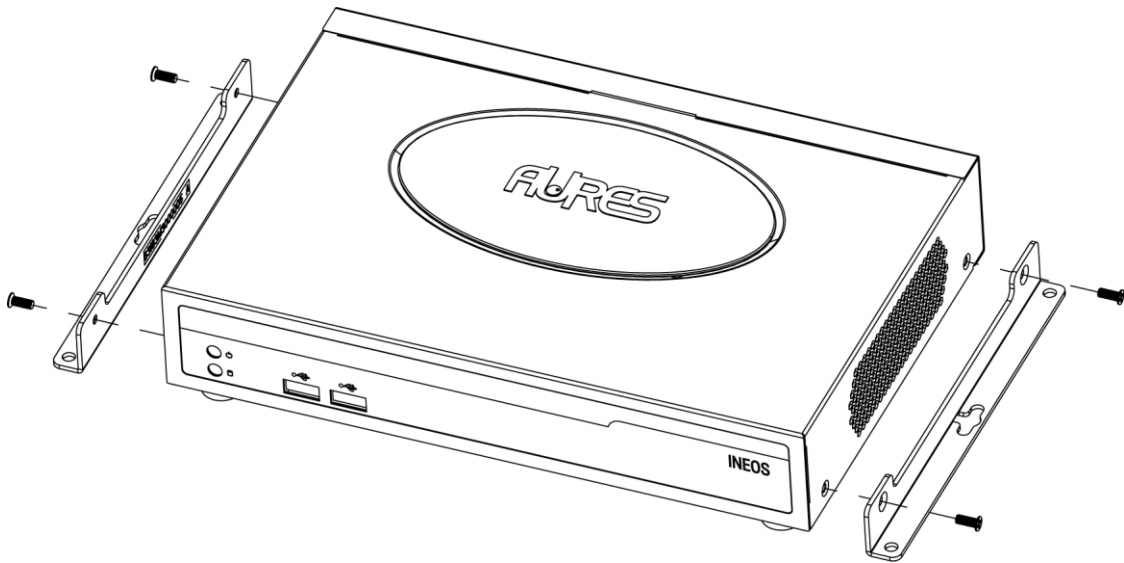

Please follow the steps to secure your own wall-mount brackets with specified screws to fix the system box onto the wall.

- Specified screws: M4.0*0.7P
- Suggested length: over 5 mm

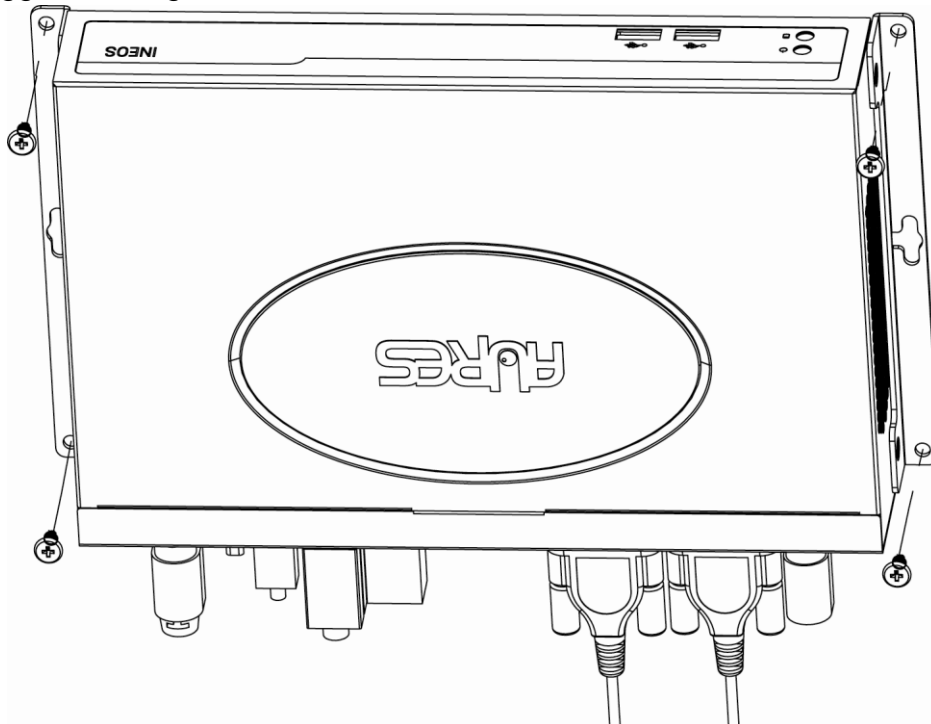

Warning



Mounting brackets installation should be operated by professional technician, please contact the service technician or your retail if you need this service. Improper installation of mounting bracket can result in serious personal injury!

3-3. Memory Replacing

1. Unfasten 4 screws of mounting brackets and open the top cover.
2. Remove the top cover before memory replacement.
3. Use both fingers to pull the ejector clips out of the sides of the module.
4. Slide out to remove the memory module from the memory slot.
5. Slide the memory module into the memory slot and press down until the ejector clips click in place.

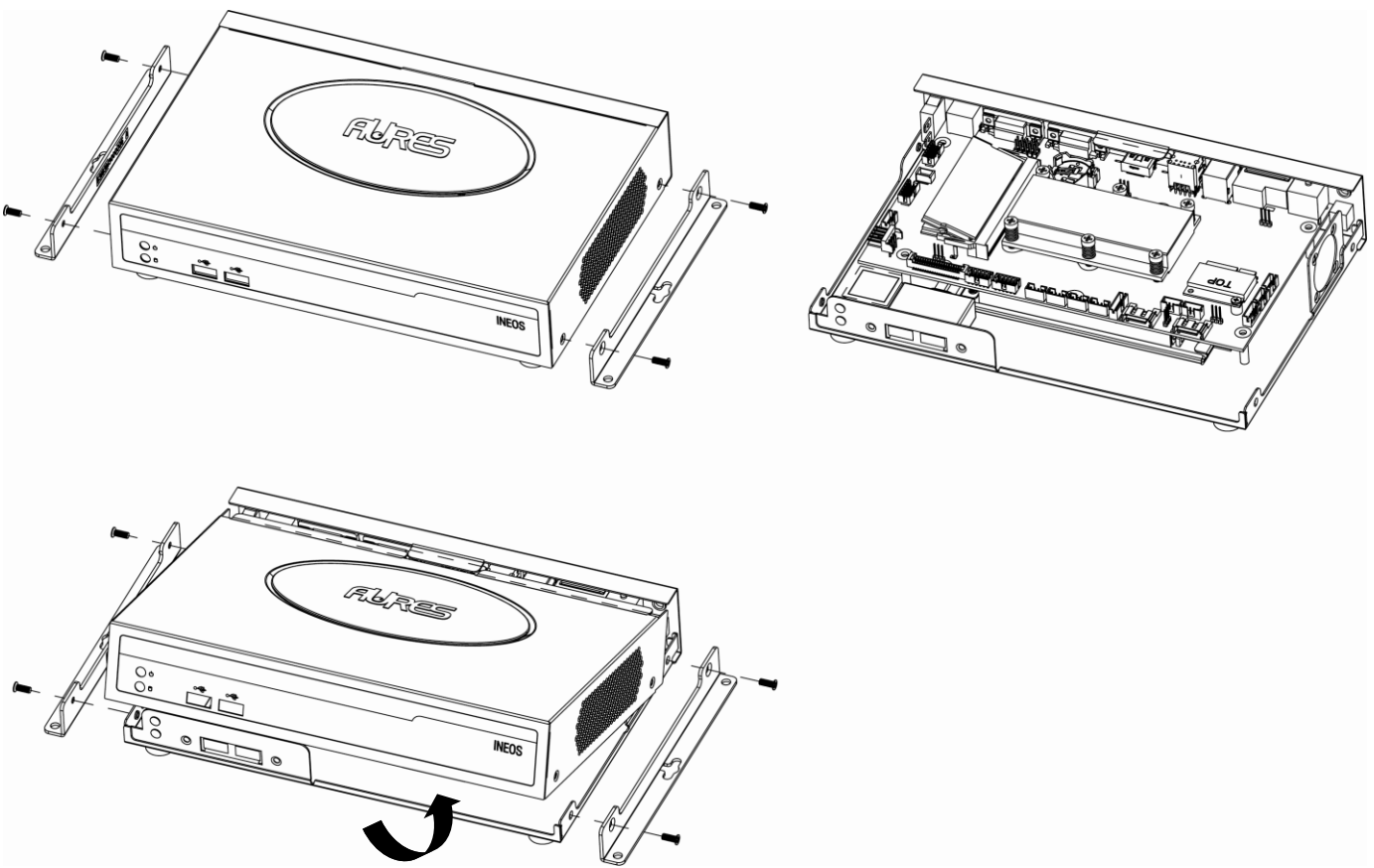

<p>Warning</p> 	<p><i>Mounting brackets installation should be operated by professional technician, please contact the service technician or your retail if you need this service. Improper installation of mounting bracket can result in serious personal injury!</i></p>
---	---

4. Specification

System	
CPU	Intel® Cedarview N2800 1.86GHz
Front Side Bus	800/1066 MHz
PCH	NM10
Storage	
HDD Support	1 x 2.5" SATA HDD
Memory	
DRAM	1 x 204-pin DDR3, 800/1066 MHz (Max:4GB)
I/O Ports	
Display	1 x VGA D-SUB 15-pin 1 x HDMI port
USB	2 x USB 2.0 port (Front side) 2 x USB 2.0 port (Rear side) 1 x powered USB 12V, Max.1A (Rear side)
Gigabit Ethernet	1 x RJ45 LAN port with two LED indicators
Cash Drawer	1 x RJ11 with 12V/24V jumper selectable power (Max.2A)
COM	4 x D-SUB 9-pin port COM1 & COM2: with RI/5V/12V selectable by BIOS (Max.1A)
Key Board / Mouse	1 x mini DIN 6-pin
Line out	1 x Audio Jack
Indicators	2 x LEDs (Power: Green & HDD: Red)
Other Expansion	
Mini-PCIe	Expansion for wireless module
Internal USB	2 x USB 2.0 port pin header (available)
Internal COM	1 x internal pin header

5. Jumper Setting

5-1. Motherboard Layout

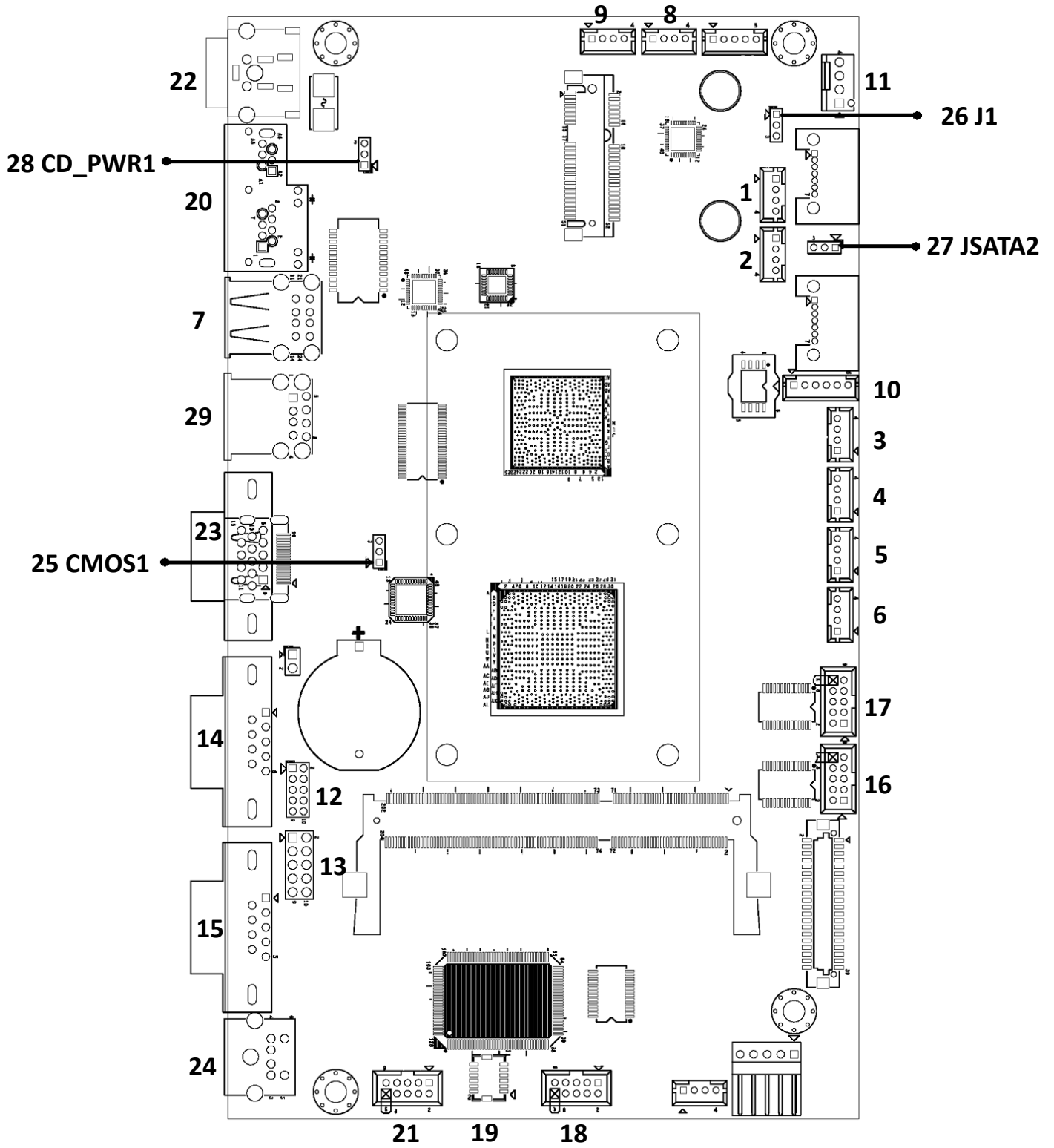

5-2. Connectors & Functions

No.	Connector	Purpose
1	SATA_PWR1	SATA1 Power
2	SATA_PWR2	SATA2 Power
3	USB1	USB1 Header
4	USB2	USB2 Header
5	USB3	USB3 Header
6	USB4	USB4 Header
7	USB5	USB5/USB6 Connector
8	SPK_OUT1	Speaker Out
9	LINE_OUT1	Line Out
10	MSR1	PS2 Mouse Header
11	SYS_FAN1	System Fan Header
12	VGA1	VGA Header
13	LPC1	Low Pin Count Header
14	COM1	COM1 Connector
15	COM2	COM2 Connector
16	COM3	COM3 Header
17	COM4	COM4 Header
18	COM5	COM5 Header
19	LED1	LED Panel Header
20	RJ1	CD/LAN JACK
21	J2	Status LED header
22	DC_IN1	DC JACK
23	HDMI1	HDMI Connector
24	KBMS1	PS2 KB/MS Connector
25	CMOS1	CMOS Clear Header
26	J1	Blight Select
27	JSATA2	SATA2 Power ON/OFF
28	CD_PWR1	Cash Drawer VCC Select
29	PUSB1	Power USB Connector

5-3. Jumper Setting

CMOS setting (No. 25 referring to 5-2 table)

Function	CMOS1	Footprint
Normal ◀	3 2 1	
Clear CMOS	3 2 1	

Manufacturer Default Setting : ◀

Monitor brightness setting (No. 26 referring to 5-2 table)

Function	J1	Footprint
Software Control ◀	1 2 3	
Hardware Control	1 2 3	

Manufacturer Default Setting : ◀

SATA2 power setting (No. 27 referring to 5-2 table)

Function	JSATA2	Footprint
ON	1 2 3	
OFF ◀	1 2 3	

Manufacturer Default Setting : ◀

Cash drawer VCC select (No. 28 referring to 5-2 table)

Function	CD_PWR1	Footprint
+12V	3 2 1	
+24V ◀	3 2 1	

Manufacturer Default Setting : ◀

5-4. Pin Define (referring to 5-2 table)

No. 1 & 2

SATA_PWR1,SATA_PWR2	
1	12V
2	Ground
3	Ground
4	VCC5

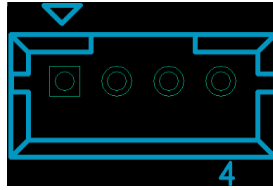

No. 3,4,5 & 6

USB1,USB2,USB3,USB4	
1	USB_PWR
2	USBN
3	USBP
4	Ground



No. 8

SPK_OUT1	
1	SPK_R+
2	SPK_R-
3	SPK_L-
4	SPK_L+

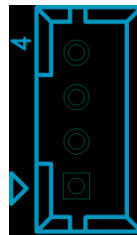

No. 9

LINE_OUT1	
1	LOUT_R
2	LOUT_JD
3	Ground
4	LOUT_L

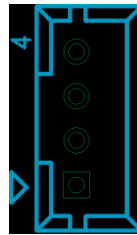

No. 10

MSR1	
1	5V_PS2
2	KB_DATA
3	NC
4	KB_CLK
5	KB_EN
6	Ground



No. 12

VGA1			
1	RED	2	DDC_DATA
3	GREEN	4	DDC_CLK
5	BLUE	6	VCC5
7	HSYNC	8	Ground
9	VSYNC	10	Ground



No. 13

LPC1			
1	Clock	2	LAD1
3	PCIRST	4	LAD0
5	LFRAME	6	VCC3
7	LAD3	8	Ground
9	LAD2	10	Ground

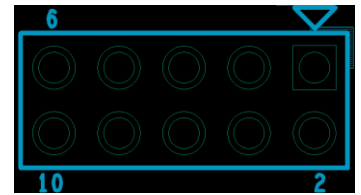

No. 16, 17 & 18

COM3,COM4,COM5			
1	DCD	2	DSR
3	RXD	4	RTS
5	TXD	6	CTS
7	DTR	8	RI
9	Ground	10	Key

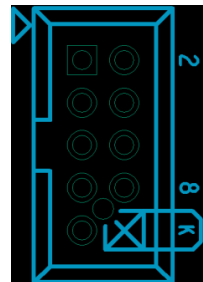

No. 19

LED1			
1	SLP5_L	2	Ground
3	SUSLED#	4	SATALED
5	3VSB	6	LANLED
7	SDA	8	SCK
9	PWRBTN	10	Ground
11	VCC5	12	OSD_INT_L

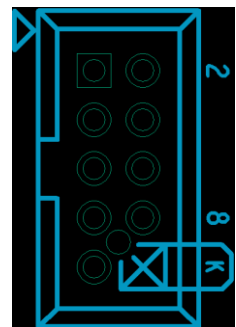

No. 20

RJ1	
1	GND
2	Data_Out0
3	Data_In0
4	Power
5	Data_Out1
4	GND



No. 21

J2			
1	VCC3	2	SATALED
3	PWRLED+	4	PWRLED-
5	PWRBTN	6	GND
7	VCC3	8	GND
9	GND	10	Key

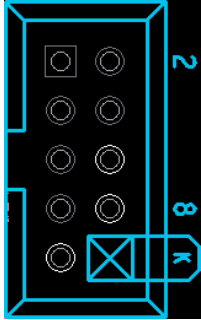

6. Drivers Installation

Installing Windows 7 32bit Device Driver

6-1. Chipset Driver

Start chipset driver installing process by clicking file “infinst_autol” of folder “Chipset”.

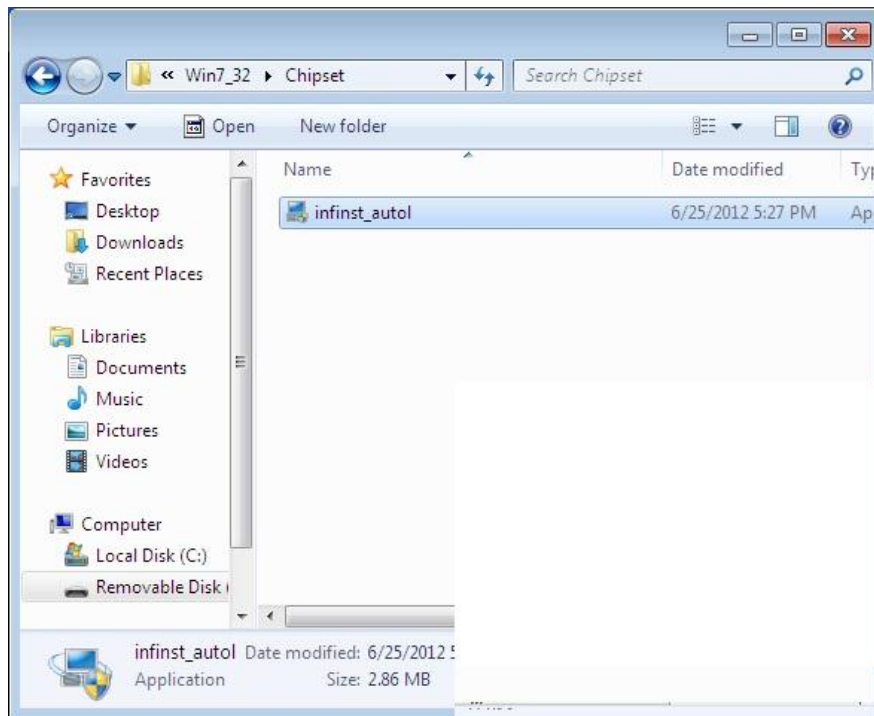

Installing process is as below (from left to right)



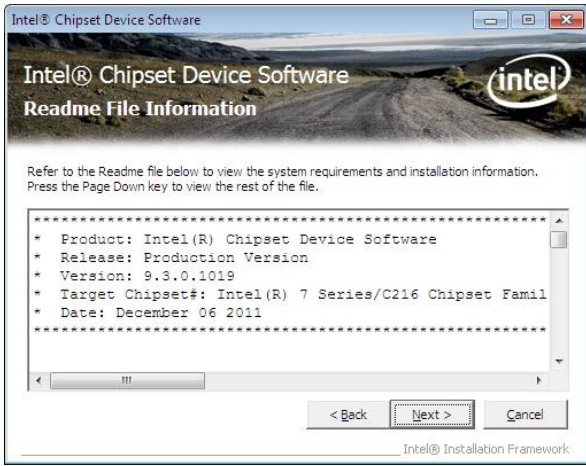

6-2. Graphic Driver

Start graphic driver installing process by clicking file “Win7” of folder “Graphic”.

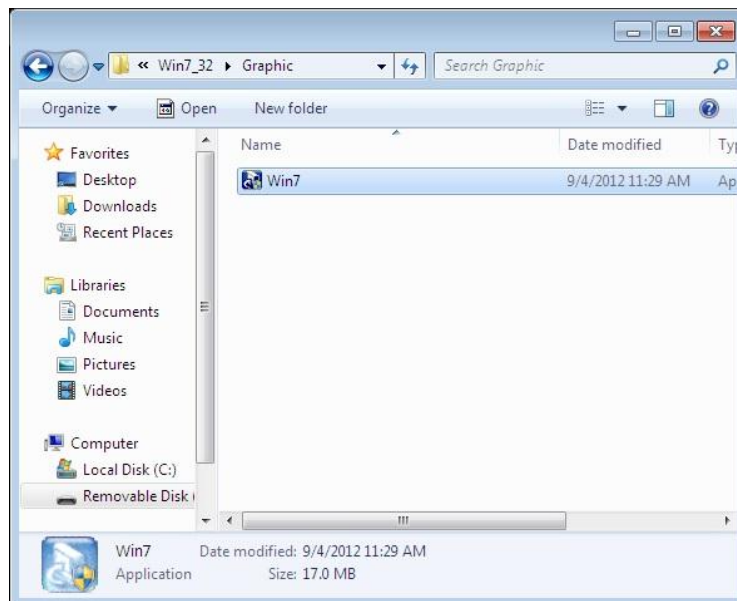

Installing process is as below (from left to right).

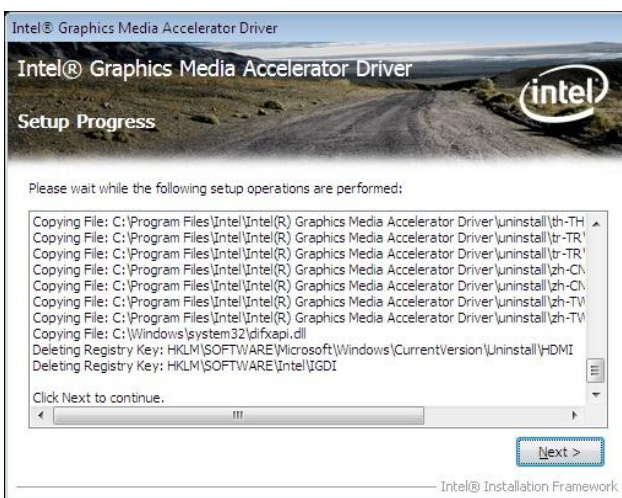
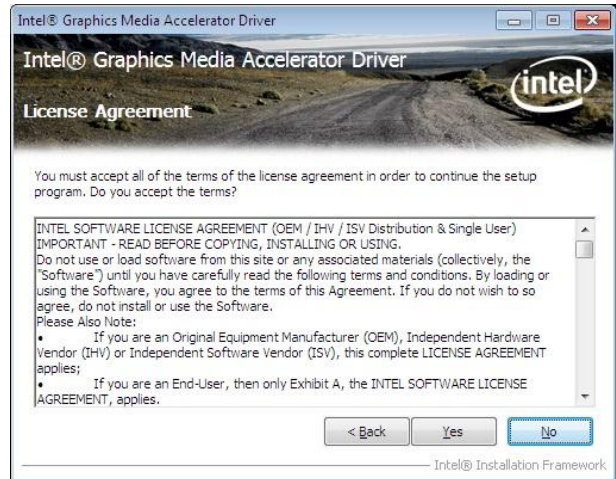
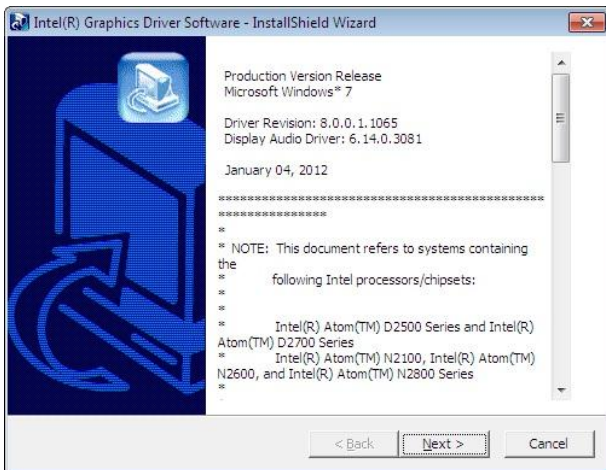

6-3. Audio Driver

Start audio driver installing process by clicking file “Vista_Win7_Win8_R270” of folder “Audio”.



Installing process is as below (From left to right).

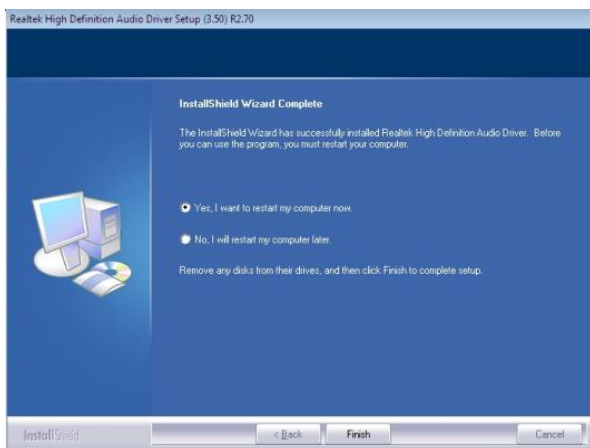
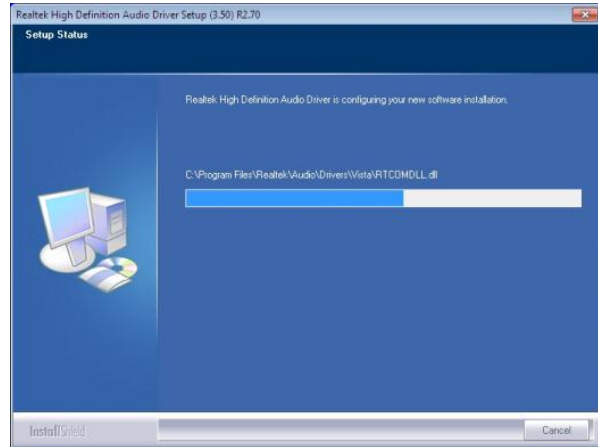
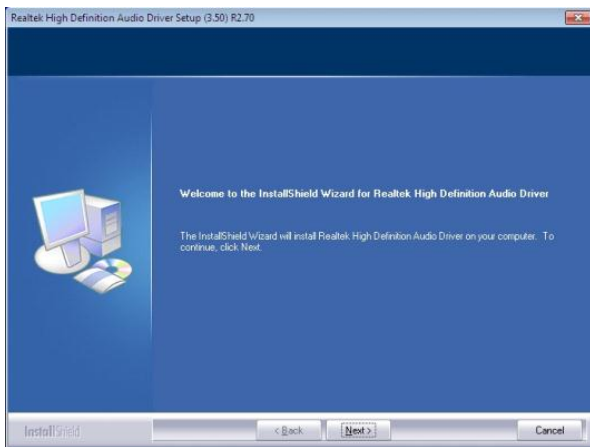

6-4. LAN Driver

Start LAN driver installing process by clicking file “setup” of folder “LAN”.

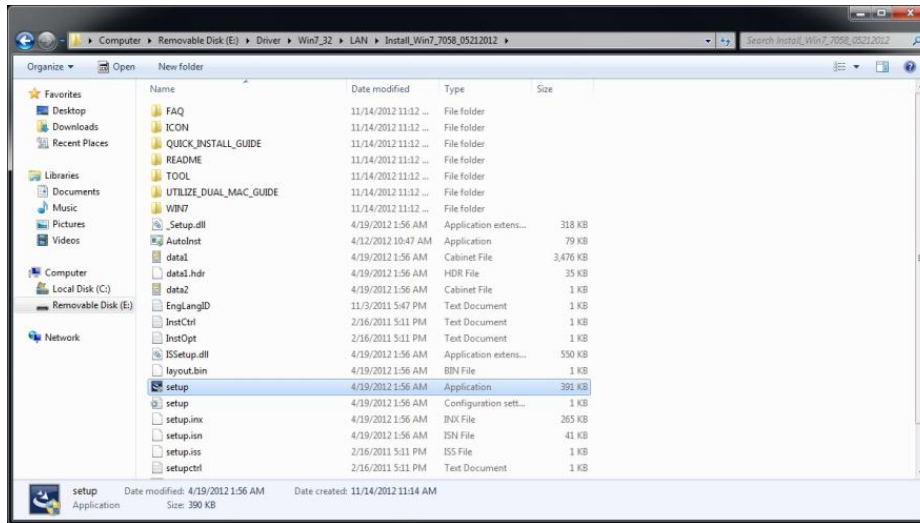

Installing process is as below.

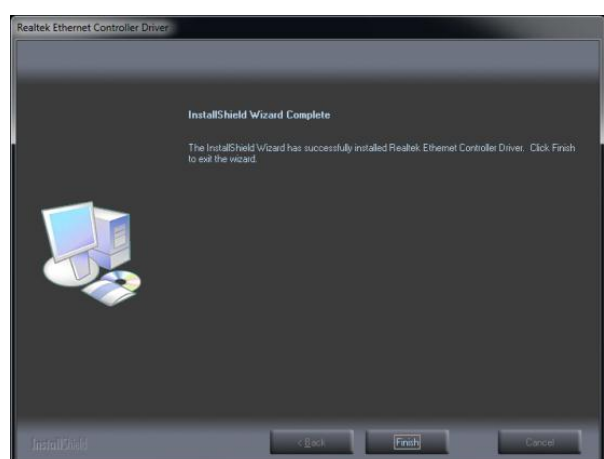
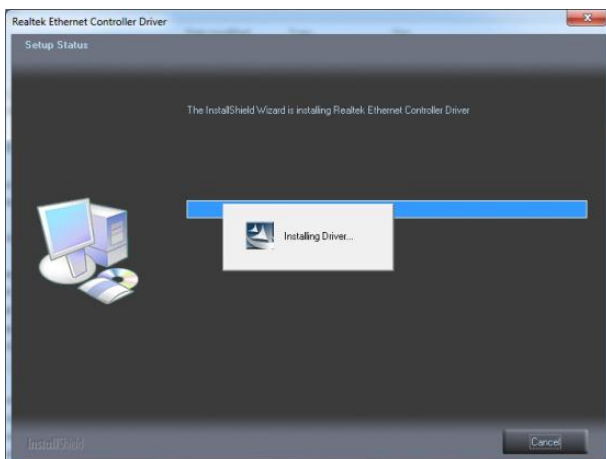
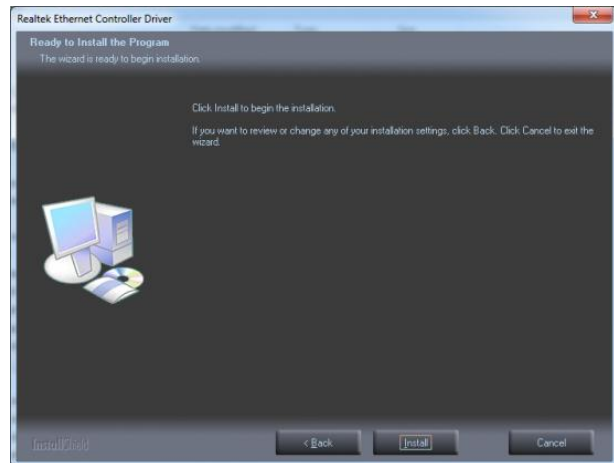
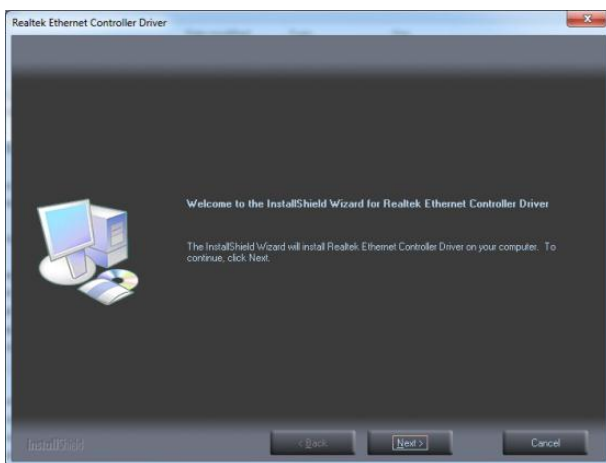

Appendix: Drivers Installation

To download the most recent drivers and utilities, and obtain advice regarding the installation of your equipment, please visit the AURES Technical Support Website:

www.ares-support.fr (French)
www.ares-support.fr/UK (English)
www.ares-support.fr/GE (German)